



Tee
SOC



Reducing Tee
SOC X SOC X FIPT



Tee
FIPT X FIPT X FIPT



1/4 Elbow
SOC



1/4 Reducing Elbow
SOC X FIPT



1/4 Elbow
FIPT X FIPT



1/4 Street Elbow
SPIG X SOC



1/4 Street Elbow
MIPT X SOC



Side Outlet Elbow
SOC X SOC X FIPT



Deep Socket 1/8 Elbow
SOC X SOC



Cross
SOC



Reducing Coupling
SOC



Female Adapter
SOC X FIPT



Male Adapter
SOC X FIPT



Reducing Bushing Flush
SPIG X SOC



Reducing Bushing Flush
SPIG X FIPT



Reducing T.T. Bushing Flush
MIPT X FIPT



Cap
FIPT



Plug
MIPT



Male Adapter
SPIG X MIPT



Insert Adapter
MIPT



Wye
SOC



Female Adapter
SPIG X FIPT



Deep Socket Coupling
SOC

Contact: Mr. Li Zhiyong (Owner)

Mobile(WhatsApp): +86-13467138000

Skype: qslizy

E-mail: qscasting@126.com

www.qiaoshan.co

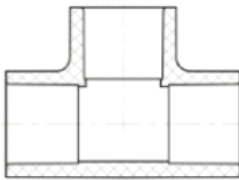
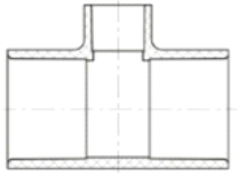

No	Product(s)	Part Number	Size(in)	Std Pk Ctn	Mstr Ctn
1	<p style="text-align: center;">Tee</p> 	401-003	3/8"	50	400
2		401-005	1/2"	50	300
3		401-007	3/4"	50	300
4		401-010	1"	50	200
5		401-012	1-1/4"	25	100
6		401-015	1-1/2"	25	100
7		401-020	2"	0	25
8		401-025	2-1/2"	0	10
9		401-030	3"	0	10
10		401-040	4"	0	6
11		401-050	5"	0	5
12		401-060	6"	0	2
13		401-080	8"	0	5
14	<p style="text-align: center;">Reducing Tee (SOC × SOC × SOC)</p> 	401-053	3/8×3/8×1/2"	50	400
15		401-074	1/2×1/2×3/4"	50	200
16		401-075	1/2×1/2×1"	50	200
17		401-094	3/4×1/2×1/2"	50	200
18		401-095	3/4×1/2×3/4"	50	300
19		401-101	3/4×3/4×1/2"	50	200
20		401-102	3/4×3/4×1"	50	200
21		401-122	1×1/2×1"	50	200
22		401-124	1×3/4×1/2"	50	300
23		401-125	1×3/4×3/4"	50	200
24		401-126	1×3/4×1"	50	200
25		401-130	1×1×1/2"	50	200
26		401-131	1×1×3/4"	50	200
27		401-132	1×1×1-1/4 "	25	150
28		401-133	1×1×1-1/2"	25	100
29		401-134	1×1×2"	25	100
30		401-156	1-1/4×1×1/2"	25	150
31		401-157	1-1/4×1×3/4"	25	150
32		401-158	1-1/4×1×1"	25	150
33		401-166	1-1/4×1-1/4×1/2"	25	150
34		401-167	1-1/4×1-1/4×3/4"	25	100
35		401-168	1-1/4×1-1/4×1"	25	100

No	Product(s)	Part Number	Size(in)	Std Pk Ctn	Mstr Ctn
36	Reducing Tee (SOC × SOC × SOC)	401-169	1-1/4×1-1/4×1-1/2"	25	100
37		401-199	1-1/2×1-1/4×1/2"	25	150
38		401-201	1-1/2×1-1/4×3/4"	25	150
39		401-202	1-1/2×1-1/4×1"	25	100
40		401-203	1-1/2×1-1/4×1-1/4"	25	100
41		401-209	1-1/2×1-1/2×1/2"	25	100
42		401-210	1-1/2×1-1/2×3/4"	25	100
43		401-211	1-1/2×1-1/2×1"	25	100
44		401-212	1-1/2×1-1/2×1-1/4"	25	100
45		401-213	1-1/2×1-1/2×2"	10	60
46		401-233	2×1×2"	10	40
47		401-238	2×1-1/2×3/4"	10	40
48		401-239	2×1-1/2×1"	10	60
49		401-241	2×1-1/2×1-1/2"	10	60
50		401-247	2×2×1/2"	10	40
51		401-248	2×2×3/4"	10	40
52		401-249	2×2×1"	10	60
53		401-250	2×2×1-1/4"	10	60
54		401-251	2×2×1-1/2"	10	40
55		401-287	2-1/2×2-1/2×1/2"	10	40
56		401-288	2-1/2×2-1/2×3/4"	10	40
57		401-289	2-1/2×2-1/2×1"	10	40
58		401-290	2-1/2×2-1/2×1-1/4"	10	40
59		401-291	2-1/2×2-1/2×1-1/2"	10	40
60		401-292	2-1/2×2-1/2×2"	8	32
61		401-333	3×3×1/2"	8	32
62		401-334	3×3×3/4"	0	10
63		401-335	3×3×1"	0	10
64		401-336	3×3×1-1/4"	8	32
65		401-337	3×3×1-1/2"	0	15
66		401-338	3×3×2"	6	24
67		401-339	3×3×2-1/2"	0	10
68		401-416	4×4×3/4"	6	24
69		401-417	4×4×1"	6	24
70		401-418	4×4×1-1/4"	0	10
71		401-419	4×4×1-1/2"	0	10
72		401-420	4×4×2"	0	10
73		401-422	4×4×3"	0	6
74		401-486	5×5×2"	0	5
75		401-488	5×5×3"	0	8
76		401-490	5×5×4"	0	6

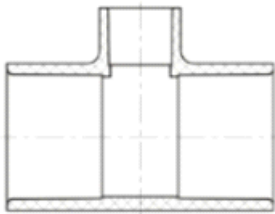

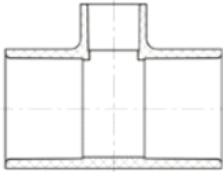
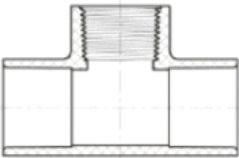
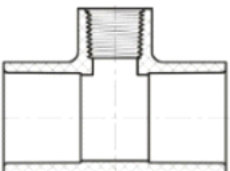
No	Product(s)	Part Number	Size(in)	Std Pk Ctn	Mstr Ctn
77	Reducing Tee (SOC x SOC x SOC) 	401-528	6×6×2"	0	6
78		401-530	6×6×3"	0	5
79		401-532	6×6×4"	0	5
80		401-582	8×8×4	0	8
81		401-585	8×8×6	0	5
82		401-624	10×10×4	0	12
83		401-626	10×10×6	0	12
84		Tee (SOC x SOC x FIPT) 	402-005	1/2"	50
85	402-007		3/4"	50	300
86	402-010		1"	50	200
87	402-012		1-1/4"	25	100
88	402-015		1-1/2"	25	100
89	402-020		2"	10	60
90	402-025		2-1/2"	0	15
91	402-030		3"	0	10
92	402-040		4"	0	6
93	Reducing Tee (SOC x SOC x FIPT) 		402-071	1/2×1/2×1/8"	50
94		402-072	1/2×1/2×1/4"	50	400
95		402-074	1/2×1/2×3/4"	50	200
96		402-094	3/4×1/2×1/2"	50	200
97		402-095	3/4×1/2×3/4"	50	300
98		402-101	3/4×3/4×1/2"	50	200
99		402-124	1×3/4×1/2"	50	300
100		402-125	1×3/4×3/4"	40	240
101		402-130	1×1×1/2"	50	200
102		402-131	1×1×3/4"	50	200
103		402-156	1-1/4×1×1/2"	25	100
104		402-157	1-1/4×1×3/4"	25	150
105		402-158	1-1/4×1×1"	25	150
106		402-166	1-1/4×1-1/4×1/2"	25	150
107		402-167	1-1/4×1-1/4×3/4"	25	150
108		402-168	1-1/4×1-1/4×1"	25	150
109		402-199	1-1/2×1-1/4×1/2"	25	150
110		402-201	1-1/2×1-1/4×3/4"	25	150
111		402-202	1-1/2×1-1/4×1"	25	150
112		402-209	1-1/2×1-1/2×1/2"	25	150
113	402-210	1-1/2×1-1/2×3/4"	25	100	
114	402-211	1-1/2×1-1/2×1"	25	100	
115	402-212	1-1/2×1-1/2×1-1/4"	25	100	
116	402-239	2×1-1/2×1"	10	40	

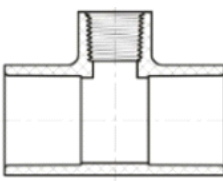
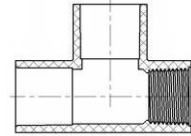
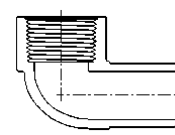
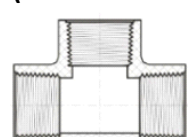
No	Product(s)	Part Number	Size(in)	Std Pk Ctn	Mstr Ctn
117	Reducing Tee (SOC x SOC x FIPT) 	402-247	2×2×1/2"	10	40
118		402-248	2×2×3/4"	10	60
119		402-249	2×2×1"	10	40
120		402-250	2×2×1-1/4"	10	60
121		402-251	2×2×1-1/2"	10	60
122		402-287	2-1/2×2-1/2×1/2"	10	40
123		402-288	2-1/2×2-1/2×3/4"	10	40
124		402-289	2-1/2×2-1/2×1"	10	40
125		402-290	2-1/2×2-1/2×1-1/4"	10	40
126		402-291	2-1/2×2-1/2×1-1/2"	10	40
127		402-292	2-1/2×2-1/2×2"	8	32
128		402-333	3×3×1/2"	8	32
129		402-334	3×3×3/4"	8	32
130		402-335	3×3×1"	8	32
131		402-336	3×3×1-1/4"	8	32
132		402-337	3×3×1-1/2"	0	10
133		402-338	3×3×2"	6	24
134		402-416	4×4×3/4"	6	24
135		402-417	4×4×1"	6	24
136		402-418	4×4×1-1/4"	0	10
137		402-419	4×4×1-1/2"	0	10
138		402-420	4×4×2"	0	10
139		402-422	4×4×3"	0	6
140		402-490	5×5×4"	0	6
141		402-525	6×6×1"	0	6
142		402-528	6×6×2"	0	4
143		402-530	6×6×3"	0	4
144		402-532	6×6×4"	0	2
145	Tee(SOCxFIPTxSOC) 	403-005	1/2	50	300
146		403-007	3/4	50	300
147	90°Street Ell (SPIG × FIPT) 	404-005	1/2"	50	400
148		404-007	3/4"	50	300
149	Tee (FIPT x FIPT x FIPT) 	405-005	1/2"	50	300
150		405-007	3/4"	50	200
151		405-010	1"	50	200
152		405-012	1-1/4"	25	150
153		405-015	1-1/2"	25	100
154		405-020	2"	10	60

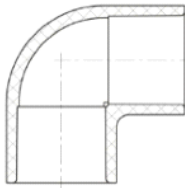
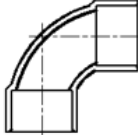
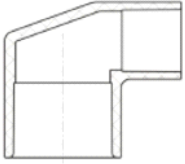
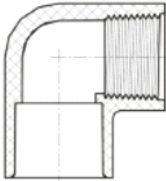
No	Product(s)	Part Number	Size(in)	Std Pk Ctn	Mstr Ctn
155	90° Elbow (SOC × SOC) 	406-003	3/8 "	50	600
156		406-005	1/2"	50	400
157		406-007	3/4"	50	200
158		406-010	1"	50	300
159		406-012	1-1/4"	25	150
160		406-015	1-1/2"	25	100
161		406-020	2"	20	80
162		406-025	2-1/2"	10	40
163		406-030	3"	0	10
164		406-040	4"	0	8
165		406-050	5"	0	4
166		406-060	6"	0	3
167		406-080	8"	0	4
168		90°Sweep Elbow(SOC × SOC) 	406-015S	1-1/2"	25
169	406-020S		2"	15	60
170	406-025S		2-1/2"	0	15
171	406-030S		3"	0	25
172	90° Reducing Elbow (SOC × SOC) 	406-053	3/8×1/2"	50	400
173		406-101	3/4×1/2"	50	300
174		406-130	1×1/2"	50	300
175		406-131	1×3/4"	50	300
176		406-166	1-1/4×1/2"	25	150
177		406-167	1-1/4×3/4"	25	150
178		406-168	1-1/4×1"	25	150
179		406-209	1-1/2×1/2"	25	100
180		406-211	1-1/2×1"	25	100
181		406-212	1-1/2×1-1/4"	25	100
182		406-249	2×1"	10	40
183		406-250	2×1-1/4"	10	40
184		406-251	2×1-1/2"	10	40
185		406-292	2-1/2×2"	10	40
186	90° Elbow (SOC x FIPT) 	407-005	1/2"	50	400
187		407-007	3/4"	50	200
188		407-010	1"	50	300
189		407-012	1-1/4"	25	150
190		407-015	1-1/2"	25	100
191		407-020	2"	10	40
192		407-025	2-1/2"	9	36
193		407-030	3"	6	24
194		407-040	4"	0	7

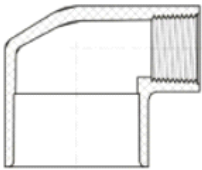
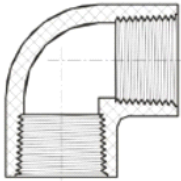
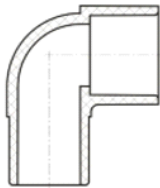
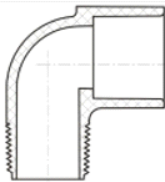
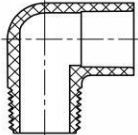
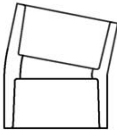
No	Product(s)	Part Number	Size(in)	Std Pk Ctn	Mstr Ctn	
195	90° Reducing Ell (SOC × FIPT) 	407-053	3/8×1/2"	50	400	
196		407-074	1/2×3/4"	50	300	
197		407-101	3/4×1/2"	50	300	
198		407-130	1×1/2"	50	200	
199		407-131	1×3/4"	50	300	
200		407-168	1-1/4×1"	25	100	
201		407-211	1-1/2×1"	25	100	
202		407-212	1-1/2×1-1/4"	15	60	
203		407-249	2×1"	10	40	
204		407-250	2×1-1/4"	10	40	
205		407-251	2×1-1/2"	10	40	
206		90° Ell (FIPT × FIPT) 	408-005	1/2"	50	400
207			408-007	3/4"	50	300
208	408-010		1"	50	300	
209	408-012		1-1/4"	25	150	
210	408-015		1-1/2"	35	140	
211	408-020		2"	10	60	
212	90° Street Elbow (SPIG × SOC) 	409-005	1/2"	50	400	
213		409-007	3/4"	50	200	
214		409-010	1"	50	300	
215		409-012	1-1/4"	25	150	
216		409-015	1-1/2"	25	100	
217		409-020	2"	10	60	
218		409-025	2-1/2"	10	40	
219		409-030	3"	0	15	
220		409-040	4"	0	10	
221		409-060	6"	0	5	
222	90° Street Elbow (MIPT × SOC) 	410-005	1/2"	50	400	
223		410-007	3/4"	50	200	
224		410-010	1"	50	300	
225		410-012	1-1/4"	25	100	
226		410-015	1-1/2"	25	100	
227		410-020	2"	10	40	
228	90° Reducing Street Elbow (MIPT × SOC) 	410-101	3/4×1/2"	50	300	
229		410-102	3/4×1"	50	200	
230	11-1/4° Elbow (SOC × SOC) 	411-100	10"	0	0	
231		411-120	12"	0	2	

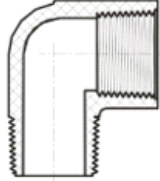
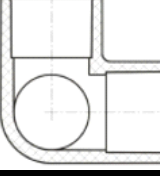
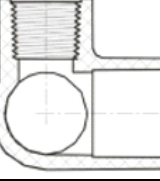
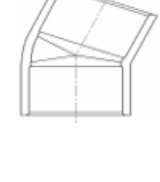
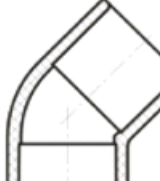
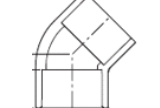
No	Product(s)	Part Number	Size(in)	Std Pk Ctn	Mstr Ctn
232	90° Street Ell (MIPT x FIPT) 	412-005	1/2"	50	400
233		412-007	3/4"	50	300
234		412-010	1"	50	300
235		412-012	1-1/4"	25	100
236		412-015	1-1/2"	25	150
237		412-020	2"	10	40
238		Side Outlet Elbow (SOC x SOC x SOC) 	413-005	1/2"	50
239	413-007		3/4"	50	300
240	413-010		1"	25	150
241	413-015		1-1/2"	10	60
242	413-020		2"	10	40
243	Side Outlet Ell (SOC x SOC x SOC) 		414-005	1/2"	50
244		414-007	3/4"	50	300
245		414-101	3/4x3/4x1/2"	50	200
246		414-010	1"	20	80
247		414-130	1x1x1/2"	50	200
248		22.5°Elbow (SOC x SOC) 	416-015	1-1/2"	20
249	416-020		2"	20	120
250	416-025		2-1/2"	10	60
251	416-030		3"	0	20
252	416-040		4"	0	12
253	416-060		6"	0	4
254	416-100		10"	0	0
255	45°Elbow (SOC x SOC) 		417-005	1/2"	50
256		417-007	3/4"	50	200
257		417-010	1"	50	300
258		417-012	1-1/4"	25	150
259		417-015	1-1/2"	25	100
260		417-020	2"	25	100
261		417-025	2-1/2"	10	40
262		417-030	3"	0	15
263		417-040	4"	4	16
264		417-050	5"	0	10
265		417-060	6"	0	5
266		417-080	8"	0	6
267		417-100	10"	0	4
268	Deep Socket 45°Elbow (SOC x SOC) 	417-020DS	2"	20	80
269		417-025DS	2-1/2"	0	0
270		417-030DS	3"	0	25

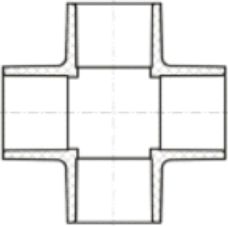
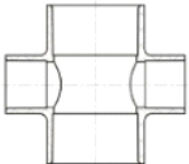
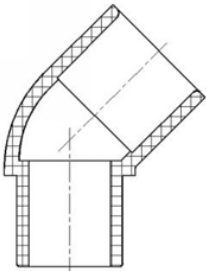
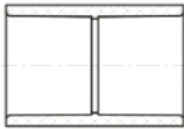
No	Product(s)	Part Number	Size(in)	Std Pk Ctn	Mstr Ctn	
271	Cross (SOC x SOC x SOC x SOC) 	420-005	1/2"	50	200	
272		420-007	3/4"	50	200	
273		420-010	1"	25	100	
274		420-012	1-1/4"	0	50	
275		420-015	1-1/2"	0	25	
276		420-020	2"	8	32	
277		420-025	2-1/2"	0	10	
278		420-030	3"	0	6	
279		420-040	4"	0	6	
280		420-060	6"	0	2	
281		Reducing Cross (SOC x SOC x SOC x SOC) 	420-101	3/4x3/4x1/2x1/2"	50	300
282			420-249	2x2x1x1"	10	40
283	420-251		2x2x1-1/2x1-1/2"	10	40	
284	420-335		3x3x1x1"	0	18	
285	420-337		3x3x1-1/2x1-1/2"	0	15	
286	420-338		3x3x2x2"	0	12	
287	420-419		4x4x1-1/2x1-1/2"	0	8	
288	420-420		4x4x2x2"	0	6	
289	420-422		4x4x3x3"	0	5	
290	420-528		6x6x2x2"	0	3	
291	420-532		6x6x4x4"	0	2	
292	45°Street Elbow (SPIG x SOC) 		427-005	1/2"	50	600
293		427-007	3/4"	50	200	
294		427-010	1"	50	200	
295		427-012	1-1/4"	25	100	
296		427-015	1-1/2"	25	150	
297		427-020	2"	25	100	
298		427-025	2-1/2"	10	40	
299		427-030	3"	5	30	
300		427-040	4"	0	20	
301		427-060	6"	0	8	
302		427-080	8"	0	0	
303		427-100	10"	0	4	
304	Coupling (SOC x SOC) 	429-003	3/8"	50	600	
305		429-005	1/2"	50	600	
306		429-007	3/4"	50	400	
307		429-010	1"	50	200	
308		429-012	1-1/4"	25	150	
309		429-015	1-1/2"	25	100	
310		429-020	2"	25	100	

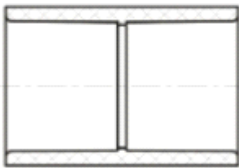
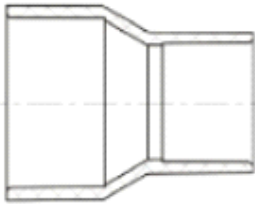
No	Product(s)	Part Number	Size(in)	Std Pk Ctn	Mstr Ctn	
311	Coupling (SOC x SOC) 	429-025	2-1/2"	12	72	
312		429-030	3"	10	40	
313		429-040	4"	6	24	
314		429-050	5"	0	15	
315		429-060	6"	0	6	
316		429-080	8"	0	8	
317		429-100	10"	0	8	
318		429-120	12"	0	2	
319		Reducing Coupling (SOC x SOC) 	429-101	3/4x1/2"	50	400
320			429-130	1x1/2"	25	300
321	429-131		1x3/4"	50	300	
322	429-166		1-1/4x1/2"	25	150	
323	429-167		1-1/4x3/4"	25	150	
324	429-168		1-1/4x1"	25	150	
325	429-209		1-1/2x1/2"	25	150	
326	429-210		1-1/2x3/4"	25	150	
327	429-211		1-1/2x1"	25	100	
328	429-212		1-1/2x1-1/4"	25	100	
329	429-247		2x1/2"	10	80	
330	429-248		2x3/4"	10	80	
331	429-249		2x1"	25	150	
332	429-250		2x1-1/4"	10	80	
333	429-251		2x1-1/2"	10	80	
334	429-291		2-1/2x1-1/2"	10	40	
335	429-292		2-1/2x2"	10	40	
336	429-338		3x2"	8	32	
337	429-340		3x2-1/2"	8	32	
338	429-420		4x2"	4	16	
339	429-421		4x2-1/2"	6	24	
340	429-422		4x3"	4	16	
341	429-528		6x2"	0	10	
342	429-530		6x3"	0	15	
343	429-532		6x4"	0	5	
344	429-582		8x4"	0	12	
345	429-585		8x6"	0	12	
346	429-626		10x6"	0	8	
347	429-628		10x8"	0	8	
348	429-668		12x8"	0	3	
349	429-670	12x10"	0	3		

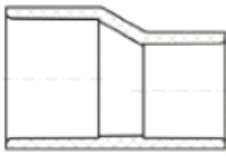
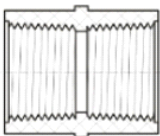
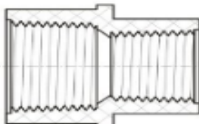
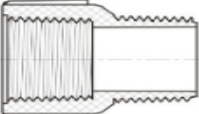
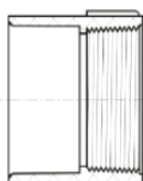
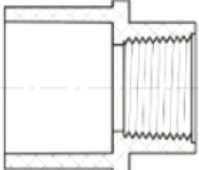
No	Product(s)	Part Number	Size(in)	Std Pk Ctn	Mstr Ctn
350	Eccentric Reducer Coupling (SOC x SOC) 	429-168E	1-1/4x1"	25	150
351		429-212E	1-1/2x1-1/4"	25	100
352		429-251E	2x1-1/2"	10	80
353		429-292E	2-1/2x2"	10	60
354		429-338E	3x2"	9	36
355		429-420E	4x2"	0	15
356		429-421E	4x2-1/2"	6	24
357		429-422E	4x3"	0	12
358		429-528E	6x2"	0	3
359		429-530E	6x3"	0	3
360		429-532E	6x4"	0	5
361		Coupling (FIPT x FIPT) 	430-005	1/2"	50
362	430-007		3/4"	50	400
363	430-010		1"	50	200
364	430-012		1-1/4"	10	120
365	430-020		2"	10	80
366	Reducing Coupling (FIPT x FIPT) 	430-101	3/4x1/2"	50	400
367		430-131	1x3/4"	50	300
368	Riser Extension (FIPTxMIPT) 	434-005	1/2"	50	600
369		434-007	3/4"	50	400
370	Female Adapter (SOC x FIPT) 	435-003	3/8"	100	1200
371		435-005	1/2"	50	600
372		435-007	3/4"	50	400
373		435-010	1"	50	200
374		435-012	1-1/4"	25	100
375		435-015	1-1/2"	25	100
376		435-020	2"	10	80
377		435-025	2-1/2"	10	40
378		435-030	3"	10	40
379		435-040	4"	6	36
380		Reducing Female Adapter(SOC x FIPT) 	435-072	1/2x1/4"	50
381	435-073		1/2x3/8"	50	600
382	435-074		1/2x3/4"	100	600
383	435-101		3/4x1/2"	50	400
384	435-102		3/4x1"	25	200
385	435-130		1x1/2"	50	200
386	435-131		1x3/4"	50	200
387	435-133		1x1-1/2"	25	150
388	435-168		1-1/4x1"	25	100

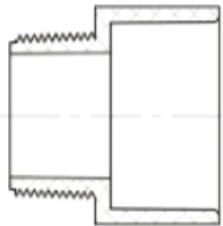
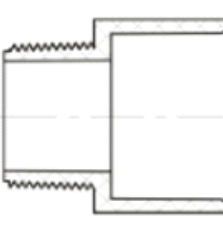
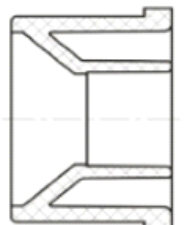
No	Product(s)	Part Number	Size(in)	Std Pk Ctn	Mstr Ctn
389	Male Adapter (MIPT × SOC) 	436-003	3/8"	50	600
390		436-005	1/2"	50	600
391		436-007	3/4"	50	400
392		436-010	1"	50	200
393		436-012	1-1/4"	25	150
394		436-015	1-1/2"	25	100
395		436-020	2"	25	100
396		436-025	2-1/2"	10	40
397		436-030	3"	10	60
398		436-040	4"	4	16
399		436-060	6"	0	6
400	Reducing Male Adapter(MIPT× SOC) 	436-053	3/8×1/2"	50	600
401		436-073	1/2×3/8"	50	600
402		436-074	1/2×3/4"	50	400
403		436-075	1/2×1"	40	240
404		436-101	3/4×1/2"	50	600
405		436-102	3/4×1"	50	300
406		436-131	1×3/4"	50	400
407		436-132	1×1-1/4"	50	300
408		436-133	1×1-1/2"	50	300
409		436-168	1-1/4×1"	25	200
410		436-169	1-1/4×1-1/2"	25	150
411		436-212	1-1/2×1-1/4"	25	100
412		436-213	1-1/2×2"	25	100
413		436-251	2×1-1/2"	10	80
414		436-252	2×2-1/2"	10	40
415		436-253	2×3"	10	60
416		436-342	3×4"	5	30
417	Reducing Bushing Flush Style(SPIG × SOC) 	437-072	1/2×1/4"	50	600
418		437-073	1/2×3/8"	50	600
419		437-101	3/4×1/2"	50	600
420		437-130	1×1/2"	50	400
421		437-131	1×3/4"	50	400
422		437-166	1-1/4×1/2"	25	300
423		437-167	1-1/4×3/4"	25	300
424		437-168	1-1/4×1"	25	300
425		437-209	1-1/2×1/2"	25	150
426		437-210	1-1/2×3/4"	25	150
427		437-211	1-1/2×1"	25	150
428		437-212	1-1/2×1-1/4"	25	150
429		437-247	2×1/2"	10	80

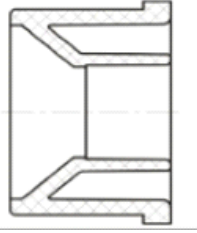
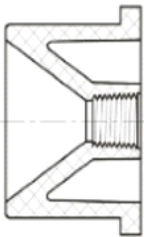
No	Product(s)	Part Number	Size(in)	Std Pk Ctn	Mstr Ctn	
430		437-248	2×3/4"	10	60	
431		437-249	2×1"	10	80	
432		437-250	2×1-1/4"	10	80	
433		437-251	2×1-1/2"	10	80	
434		437-287	2-1/2×1/2"	10	60	
435		437-288	2-1/2×3/4"	10	60	
436		437-289	2-1/2×1"	10	60	
437		437-290	2-1/2×1-1/4"	10	60	
438		437-291	2-1/2×1-1/2"	10	60	
439		437-292	2-1/2×2"	10	60	
440		437-334	3×3/4"	10	40	
441		437-335	3×1"	10	40	
442		437-336	3×1-1/4"	10	40	
443		437-337	3×1-1/2"	10	40	
444		437-338	3×2"	10	40	
445		437-339	3×2-1/2"	15	90	
446		437-420	4×2"	6	24	
447		437-421	4×2-1/2"	6	24	
448		437-422	4×3"	6	24	
449		437-488	5×3"	0	15	
450		437-490	5×4"	0	15	
451		437-528	6×2"	0	9	
452		437-530	6×3"	0	9	
453		437-532	6×4"	0	9	
454		437-534	6×5"	0	20	
455		437-582	8×4"	0	3	
456		437-585	8×6"	0	3	
457		437-623	10×3"	0	12	
458		437-624	10×4"	0	12	
459		437-626	10×6"	0	12	
460		437-628	10×8"	0	16	
461		437-668	12×8"	0	1	
462			438-052	3/8×1/4"	50	600
463			438-071	1/2×1/8"	50	600
464			438-072	1/2×1/4"	50	600
465			438-073	1/2×3/8"	50	600
466			438-098	3/4×1/4"	50	600
467			438-101	3/4×1/2"	100	800
468	438-128		1×1/4"	50	400	
469	438-129		1×3/8"	50	400	
470	438-130		1×1/2"	50	400	

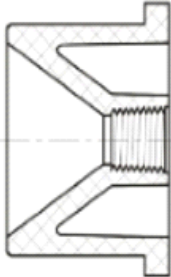
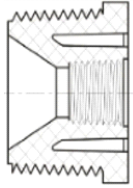
No	Product(s)	Part Number	Size(in)	Std Pk Ctn	Mstr Ctn	
471	Reducing Bushing Flush Style(SPIG × FIPT) 	438-131	1×3/4"	50	400	
472		438-166	1-1/4×1/2"	25	200	
473		438-167	1-1/4×3/4"	25	200	
474		438-168	1-1/4×1"	25	100	
475		438-207	1-1/2×1/4"	25	200	
476		438-209	1-1/2×1/2"	25	150	
477		438-210	1-1/2×3/4"	25	100	
478		438-211	1-1/2×1"	25	150	
479		438-212	1-1/2×1-1/4"	25	150	
480		438-245	2×1/4"	10	120	
481		438-247	2×1/2"	10	120	
482		438-248	2×3/4"	10	120	
483		438-249	2×1"	10	120	
484		438-250	2×1-1/4"	10	120	
485		438-251	2×1-1/2"	10	120	
486		438-288	2-1/2×3/4"	10	60	
487		438-289	2-1/2×1"	10	60	
488		438-290	2-1/2×1-1/4"	10	60	
489		438-291	2-1/2×1-1/2"	10	60	
490		438-292	2-1/2×2"	10	60	
491		438-335	3×1"	10	40	
492		438-336	3×1-1/4"	10	40	
493		438-337	3×1-1/2"	10	40	
494		438-338	3×2"	10	40	
495		438-339	3×2-1/2"	10	40	
496		438-420	4×2"	6	24	
497		438-421	4×2-1/2"	6	24	
498		438-422	4×3"	6	24	
499		438-490	5×4"	6	24	
500		438-528	6×2"	0	9	
501		438-530	6×3"	0	9	
502		438-532	6×4"	0	9	
503		Reducing T.T. Bushing Flush Style(MIPT x) 	439-052	3/8×1/4"	50	600
504			439-072	1/2×1/4"	150	1800
505			439-073	1/2×3/8"	50	600
506			439-098	3/4×1/4"	50	600
507			439-099	3/4×3/8"	50	600
508			439-101	3/4×1/2"	50	600
509			439-128	1×1/4"	25	300
510			439-130	1×1/2"	50	600
511			439-131	1×3/4"	50	600

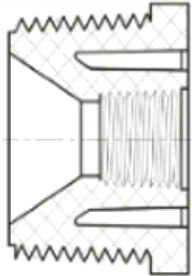
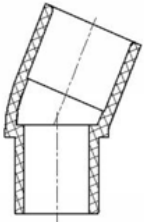
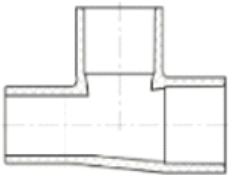
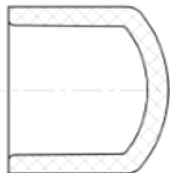
No	Product(s)	Part Number	Size(in)	Std Pk Ctn	Mstr Ctn
512	Reducing T.T. Bushing Flush Style(MIPT x FIPT) 	439-166	1-1/4x1/2"	25	300
513		439-167	1-1/4x3/4"	25	300
514		439-168	1-1/4x1"	25	300
515		439-198	1-1/2x2"	40	240
516		439-209	1-1/2x1/2"	25	200
517		439-210	1-1/2x3/4"	25	200
518		439-211	1-1/2x1"	25	200
519		439-212	1-1/2x1-1/4"	25	200
520		439-248	2x3/4"	10	120
521		439-249	2x1"	10	120
522		439-250	2x1-1/4"	10	120
523		439-251	2x1-1/2"	10	120
524		439-292	2-1/2x2"	10	60
525		439-338	3x2"	10	60
526		439-422	4x3"	6	24
527		22-1/2° STREET Elbow(SPIG x SOC) 	442-005	1/2"	50
528	442-007		3/4"	50	300
529	442-010		1"	50	200
530	442-012		1-1/4"	25	100
531	442-015		1-1/2"	30	120
532	442-020		2"	20	80
533	442-025		2-1/2"	10	60
534	442-030		3"	5	30
535	442-040		4"	4	16
536	442-060		6"	0	5
537	Street Tee (SPIG x SOC x SOC) 	444-005	1/2"	25	200
538		444-007	3/4"	15	120
539		444-010	1"	15	90
540		444-012	1-1/4"	10	40
541		444-015	1-1/2"	10	40
542		444-020	2"	10	40
543		Cap (SOC) 	447-003	3/8"	100
544	447-005		1/2"	100	1200
545	447-007		3/4"	50	600
546	447-010		1"	50	300
547	447-012		1-1/4"	25	150
548	447-015		1-1/2"	25	150
549	447-020		2"	10	80
550	447-025		2-1/2"	10	60
551	447-030		3"	10	40
552	447-040		4"	6	24

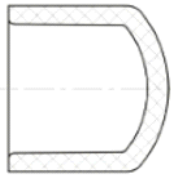
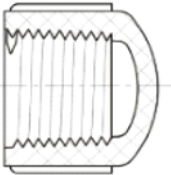
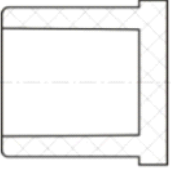
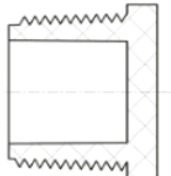
No	Product(s)	Part Number	Size(in)	Std Pk Ctn	Mstr Ctn
553	Cap (SOC) 	447-050	5"	6	24
554		447-060	6"	0	8
555		447-080	8"	0	12
556		447-100	10"	0	12
557		447-120	12"	0	6
558	Cap (FIPT) 	448-003	3/8"	100	1200
559		448-005	1/2"	100	1200
560		448-007	3/4"	50	600
561		448-010	1"	50	400
562		448-012	1-1/4"	25	200
563		448-015	1-1/2"	25	150
564		448-020	2"	10	120
565		448-025	2-1/2"	10	60
566		448-030	3"	10	40
567		448-040	4"	6	36
568		448-060	6"	0	13
569	Plug (SPIG) 	449-003	3/8"	150	1800
570		449-005	1/2"	100	1200
571		449-007	3/4"	50	600
572		449-010	1"	50	400
573		449-012	1-1/4"	25	200
574		449-015	1-1/2"	25	150
575		449-020	2"	10	120
576		449-025	2-1/2"	10	60
577		449-030	3"	10	40
578		449-040	4"	6	24
579		449-060	6"	0	8
580	Plug (MIPT) 	450-003	3/8"	100	1200
581		450-005	1/2"	150	1800
582		450-007	3/4"	100	1200
583		450-010	1"	50	400
584		450-012	1-1/4"	25	300
585		450-015	1-1/2"	25	200
586		450-020	2"	10	120
587		450-025	2-1/2"	10	60
588		450-030	3"	10	40
589		450-040	4"	6	24
590		450-060	6"	4	16

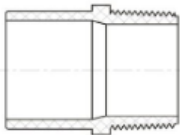
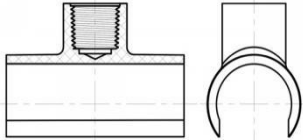
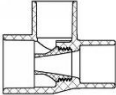
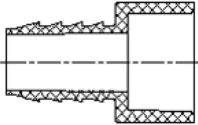
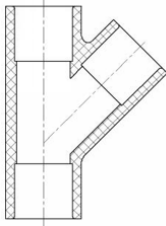
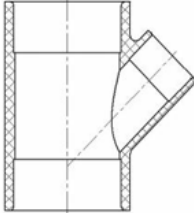
No	Product(s)	Part Number	Size(in)	Std Pk Ctn	Mstr Ctn
591	Male Adapter (take off) (SPIG x MIPT) 	461-005	1/2"	50	600
592		461-007	3/4"	50	400
593		461-010	1"	50	300
594		461-015	1-1/2"	25	100
595		461-020	2"	25	100
596	Snap-on Saddle(IPS O.D.XFIPT) 	464-007	3/4"	25	200
597		464-101	3/4x1/2"	0	0
598		464-130	1x1/2"	25	150
599		464-131	1x3/4"	0	0
600	Venturien Tee(SOCxSOC(SPIG)xSOC(SPIG)) 	473-210	1-1/2x1-1/2x3/4"	30	120
601		473-825	1x3/4x3/4"	40	240
602	Insert Adapter (INSERTXSOC) 	474-007	3/4"	50	400
603		474-010	1"	25	200
604		474-015	1-1/2"	25	100
605		474-020	2"	20	80
606	Wye (SOC x SOC x SOC) 	475-005	1/2"	25	150
607		475-007	3/4"	20	80
608		475-010	1"	20	120
609		475-012	1-1/4"	20	80
610		475-015	1-1/2"	15	60
611		475-020	2"	10	40
612		475-025	2-1/2"	3	12
613		475-030	3"	0	6
614		475-040	4"	0	5
615		475-060	6"	0	2
616	Reducing Wye (SOC x SOC x SOC) 	475-101	3/4x3/4x1/2"	20	120
617		475-131	1x1x3/4"	20	80
618		475-210	1-1/2x1-1/2x3/4"	20	80
619		475-211	1-1/2x1-1/2x1"	20	80
620		475-212	1-1/2x1-1/2x1-1/4"	15	60
621		475-251	2x2x1-1/2"	10	40
622		475-292	2-1/2x2-1/2x2"	4	24
623		475-338	3x3x2"	0	10
624		475-339	3x3x2-1/2"	0	8
625		475-420	4x4x2"	0	5
626		475-422	4x4x3"	0	5
627		475-528	6x6x2"	0	5
628		475-530	6x6x3"	0	5
629		475-532	6x6x4"	0	3

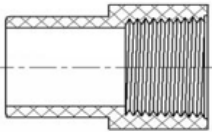
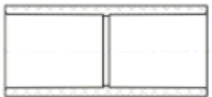
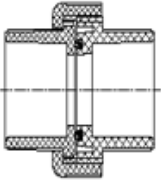
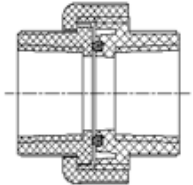
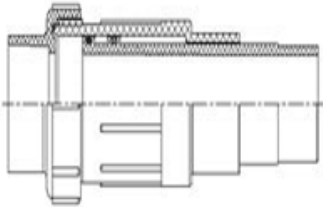
No	Product(s)	Part Number	Size(in)	Std Pk Ctn	Mstr Ctn
630	Spigot Female Adapter (SPIG × FIPT) 	478-005	1/2"	50	600
631		478-007	3/4"	25	300
632		478-010	1"	40	240
633		478-012	1-1/4"	0	0
634		478-015	1-1/2"	30	120
635		478-020	2"	25	100
636		Deep Socket Coupling (SOC × SOC) 	479-005	1/2"	50
637	479-007		3/4"	50	300
638	479-010		1"	50	300
639	479-012		1-1/4"	50	200
640	479-015		1-1/2"	30	120
641	479-020		2"	0	60
642	479-025		2-1/2"	0	25
643	479-030		3"	0	20
644	479-040		4"	0	10
645	479-060		6"	0	5
646	Union w/O-ring Seal(SOC × SOC) 	497-005	1/2"	20	240
647		497-007	3/4"	10	120
648		497-010	1"	10	80
649		497-012	1-1/4"	8	64
650		497-015	1-1/2"	10	40
651		497-020	2"	5	30
652	Union w/O-ring Seal(FIPT × FIPT) 	498-005	1/2"	20	240
653		498-007	3/4"	10	120
654		498-010	1"	10	80
655		498-012	1-1/4"	8	64
656		498-015	1-1/2"	15	60
657		498-020	2"	5	30
658	Expand Repair Coupling(SOC × SPIG) 	FSF-050	1/2"	25	100
659		FSF-075	3/4"	20	80
660		FSF-100	1"	10	40
661		FSF-125	1-1/4"	6	24
662		FSF-150	1-1/2"	6	24
663		FSF-200	2"	0	18
664		FSF-250	2-1/2"	0	20
665		FSF-300	3"	0	6
666		FSF-400	4"	0	7
667		FSF-600	6"	0	2

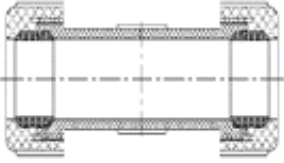
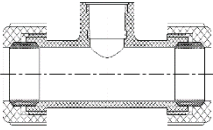
No	Product(s)	Part Number	Size(in)	Std Pk Ctn	Mstr Ctn
668	Compression Coupling (GASKET × GASKET) 	IR90-05	1/2"	30	120
669		IR90-07	3/4"	30	180
670		IR90-10	1"	10	40
671		IR90-12	1-1/4"	15	60
672		IR90-15	1-1/2"	10	40
673		IR90-20	2"	6	24
674		IR90-25	2-1/2"	0	15
675		IR90-30	3"	0	7
676		IR90-40	4"	0	10
677		IR90-60	6"	0	3
678	Compression Tee(GASKET X GASKET X FIPT) 	IR91-05	1/2"	30	180
679		IR91-07	3/4"	25	150
680		IR91-10	1"	10	40

H/HUB	Solvent Weld Socket
S	Spigot End
FPT	Female Iron Pipe Thread
MPT	Male Iron Pipe Thread
NPSM	Straight Thread for Mechanical Jpoint
SLIP	Trap End for Receiving Drain Tail Piece
W/	With
C.O.	Cleanout
S/D	Sewer and Drain
L.A.	Los Angeles